

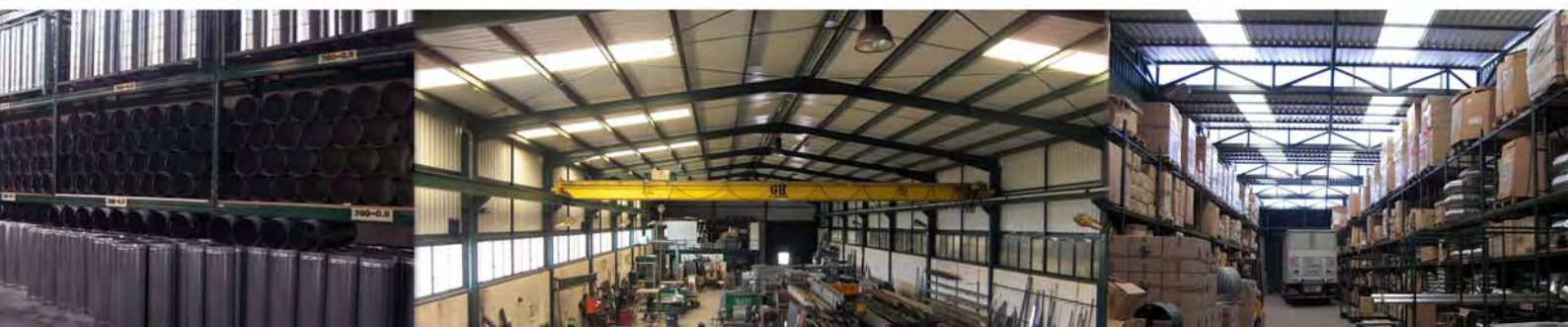

**CERRAJERIA**  
**Bellido**®



INDICE	Página
*CANALÓN METALICO REDONDO	3
*TUBO REDONDO PARA BAJANTE	3
*SOPORTES DE CANALÓN Y ABRAZADRAS	4
*ESCUADRAS O INGLETES PARA CANALÓN	4
*CODOS EXTENSIBLES Y REMATES 45° Y 90°	5
*BOCAS DE DRAGON O GÁRGOLAS	5
*REDUCCIONES PARA CANALÓN	5
*COMPLEMENTOS PARA CANALÓN PARAHOJAS, CUBETAS DE RECOGIDA, BOQUILLAS, MASILLAS.	6
*TUBOS DE CHIMENEA	7
*TUBOS Y ACCESORIOS MODULARES DOBLE PARED.	8
*TUBO HELICOIDAL Y MANGUITOS	9
*CODOS 45° Y 90° GALVANIZADO, INOXIDABLE.	9
*CODOS 45° Y 90° VITRIFICADO, ANTICALORICO, COBRE.	10
*TES DE 45° Y 90°	11
*TAPONES PARA TES.	11
*PLAFONES Y TAPAJUNTAS	11
*SOMBRETERES GALVANIZADO, VITRIFICADO, INOXIDABLE.	12
*SOMBRETERES COBRE, COLORES	13
*BASES O ARRANQUES PARA SOMBRETERES	13
*RESPIRADEROS PARA NAVES INDUSTRIALES	14
*SOMBRETERE FIJO ESTATICO	14
*CONDUCTOS CUADRADOS DE VENTILACIÓN	14
*REDUCCIONES Y AMPLIACIONES	15
*ABRAZADERAS METALICAS	15
*PUERTAS METALICAS	16
*CASETILLAS PARA CALENTADORES	16

E



Existencias

\*

Por encargo

No se fabrica

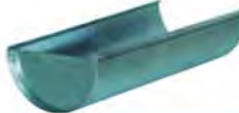
## CANALÓN METÁLICO REDONDO

	DIÁMETRO EN mm.	GALVANIZADO	LACADO BLANCO	COBRE e INOX	OTROS COLORES	EMBALADO EN UNDS.
<b>TERMINAL TAPA Y SALIDA 0,3 MTS.</b> 	140	E	E	*	*	12
	160	*	*	*	*	
	180	*	*	*	*	
	200	*	*	*	*	
<b>TERMINAL TAPA 0,3 MTS.</b> 	140	E	E	*	*	24
	160	*	*	*	*	
	180	*	*	*	*	
	200	*	*	*	*	
<b>SALIDA INTERMEDIA 0,3 MTS.</b> 	140	E	E	*	*	10
	160	*	*	*	*	
	180	*	*	*	*	
	200	*	*	*	*	
<b>CANALÓN DE 2,00 MTS.</b> 	140	E	E	*	*	METROS 50-100
	160	*	*	*	*	
	180	*	*	*	*	
	200	*	*	*	*	
<b>GRAPA UNIÓN CANAL</b> 	25X70	E	E	E	E	100 unids.

## TUBO REDONDO PARA BAJANTE

	DIÁMETRO EN mm.	GALVANIZADO	LACADO BLANCO	COBRE	OTROS COLORES	EMBALADO EN UNDS.
<b>BA-1</b> LONGUITUD 1,00 MTS. 	75	E	E	*	*	10
	90	E	*	*	*	
	100	E	*	*	*	
	110	E	*	*	*	
	125	E	*	*	*	
<b>BA-2</b> LONGUITUD 2,00 MTS.	75	E	E			10
<b>BA-3</b> LONGUITUD 3,00 MTS.	75	E				10
	<b>LARGO</b> mm.					
<b>BAJANTE REFORZADO 80X1,5 m/m.</b>	1000	E	*		*	10
	2000	E	*		*	5

CERRAJERIA

**Bellido**<sup>®</sup>

## SOPORTES DE CANALÓN Y ABRAZADERAS

DIÁMETRO EN mm.	GALVANIZADO	LACADO BLANCO	COBRE e INOX	OTROS COLORES	EMBALADO EN UNDS.
--------------------	-------------	------------------	--------------	------------------	----------------------

<b>SOPORTE CUNA</b> 	140	E	E	*	E	100
	160	E	E	*	*	100
	180	E	E	*	*	100
	200	E	E	*	*	100

<b>SOPORTE CLAVO LARGO 50 CM.</b> 	140	*	*	*	NEGRO	50
	160	*	*	*	*	50
	180	*	*	*	*	50
	200	*	*	*	*	50

<b>OTROS SOPORTES DE FIJACIÓN</b> 	GARRA	E	*	*	*	100
	TEJA	E	*	*	*	100
	PLACA	E	*	*	*	100

<b>ABRAZADERAS PARA BAJANTE</b> 	75	E	E	*	*	100
	90	E	E	*	*	100
	100	E	*	*	*	100
	110	E	*	*	*	100
	125	E	*	*	*	100

## ESCUADRAS O INGLETES PARA CANALÓN

DIÁMETRO EN mm.	GALVANIZADO	LACADO BLANCO	COBRE	OTROS COLORES	EMBALADO EN UNDS.
--------------------	-------------	------------------	-------	------------------	----------------------



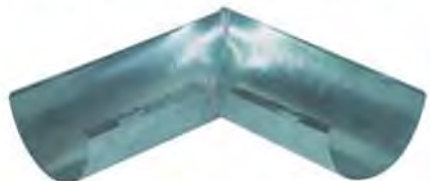

<b>ES-1 ESCUADRA CON SALIDA</b> 	140	E	E	*	*	6
	160	*	*	*	*	
	180	*	*	*	*	
	200	*	*	*	*	

<b>ES-2 ESCUADRA SIN SALIDA</b> 	140	E	E	*	*	10
	160	*	*	*	*	
	180	*	*	*	*	
	200	*	*	*	*	

CERRAJERIA

**Bellido**<sup>®</sup>

## CODOS EXTENSIBLES Y REMATES

	DIÁMETRO EN mm.	GALVANIZADO	LACADO BLANCO	COBRE	OTROS COLORES	EMBALADO EN UNDS.
<b>CO-1</b> EXTENSIBLE 40 cm. 	75	E	E	*	*	10
	90	E	E	*	*	
	100	*	*	*	*	
	110	*	*	*	*	
	125	*	*	*	*	
<b>CO-2</b> EXTENSIBLE 30 cm. 	75	E	E	*	*	10
	90	E	E	*	*	
	100	*	*	*	*	
	110	*	*	*	*	
	125	*	*	*	*	
<b>CODO REMATE 90°</b> 	75	E	E	*	*	20
	90	E	E	*	*	
	100	*	*	*	*	
	110	*	*	*	*	
	125	*	*	*	*	
<b>CODO REMATE 45°</b> 	75	E	E	*	*	20
	90	E	E	*	*	
	100	*	*	*	*	
	110	*	*	*	*	
	125	*	*	*	*	

## REDUCCIONES

	DIÁMETRO EN mm.	GALVANIZADO	LACADO BLANCO	COBRE	OTROS COLORES	EMBALADO EN UNDS.
<b>REDUCCIONES</b> para recogida de agua 	90-75	E	E	*	E	
	110-75	E	*	*	*	
	110-90	E	*	*	*	
	125-100	E	*	*	*	

## BOCAS DE DRAGÓN O GÁRGOLAS

	DIÁMETRO EN mm.	GALVANIZADO	LACADO BLANCO	COBRE	OTROS COLORES	EMBALADO EN UNDS.
<b>BOCA DE DRAGÓN SENCILLA</b> 	75	E	E	*	*	10
<b>BOCA DE DRAGÓN ARTESANAL</b> 	75	E	E	*	*	1

CERRAJERIA

**Bellido**<sup>®</sup>

## COMPLEMENTOS

DIÁMETRO EN mm.	GALVANIZADO	LACADO BLANCO	INOXIDABLE	OTROS COLORES	EMBALADO EN UNDS.
-----------------	-------------	---------------	------------	---------------	-------------------

PARAHOJAS O MORRIONES



75X125

E

NO

E

NO

cm.

CUBETA DE RECOGIDA CUADRADA CON SALIDA DE 75 M/M. O 110 M/M.



30X20X10

E

\*

\*

\*

CUBETA DE RECOGIDA CIRCULAR CON SALIDA vDE 75 M/M. O 110 M/M.



30X20X10

E

\*

\*

\*

BOQUILLA O SALIDA PARA CANALES



75

E

\*

\*

\*

50

90

E

\*

\*

\*

50

100

E

\*

\*

\*

50

110

E

\*

\*

\*

50

125

E

\*

\*

\*

50

150

E

\*

\*

\*

50

160

E

\*

\*

\*

25

200

E

\*

\*

\*

25

P.V.P

MASILLAS Y AEROSOL GALVANIZADO (PINTURA)

SILICONA TRANSLÚCIDA

E

24

MASILLA SINTEX MS-35

E

24

AEROSOL GALVA

E

12



SE RECOMIENDA  
USAR MASILLA SINTEX MS-35  
PARA LAS JUNTAS DE CANALONES  
Y ASÍ GARANTIZAR  
UNA JUNTA ESTANCA.

CERRAJERIA

**Bellido**<sup>®</sup>

## TUBOS DE CHIMENEA

### SERIE GALVANIZADA



CON LLAVE TAMBIÉN DISPONIBLE

DIÁMETRO mm.	GALVA 0,5	GALVA 0,6	GALVA 0,8
100 M/M	E		E
110 M/M	E		E
120 M/M	E		E
125 M/M	E		E
150 M/M		E	E
175 M/M		E	E
200 M/M		E	E
250 M/M		E	E
300 M/M		E	E
350 M/M			E
400 M/M			E
450 M/M			E
500 M/M			E
550 M/M			E
600 M/M			E

DIÁMETRO mm.	INOXIDABLE	ANTICALOR
--------------	------------	-----------

### SERIE INOXIDABLE Y ANTICALÓRICO GRIS ANTRACITA

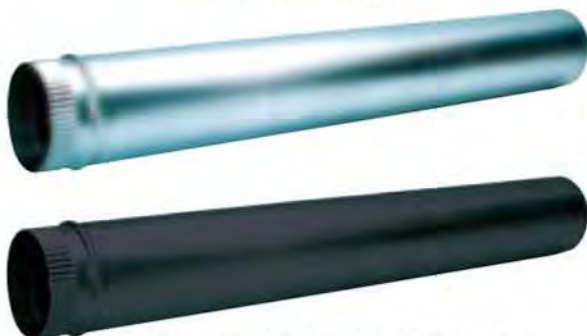

\*EN SERIE ANTICALÓRICO DISPONEMOS DE OTROS COLORES, CONSULTAR CARTA. EN OTROS COLORES (NO ANTICALÓRICO) CON LLAVE TAMBIÉN DISPONIBLE

100 M/M	E	E
110 M/M	E	E
120 M/M	E	E
125 M/M	E	E
150 M/M	E	E
175 M/M	E	E
200 M/M	E	E
250 M/M	E	E
300 M/M	E	E
350 M/M	E	
400 M/M	E	
450 M/M	E	
500 M/M	E	
550 M/M	E	
600 M/M	E	

DIÁMETRO mm.	VITRIFICADO	COBRE
--------------	-------------	-------

### SERIE VITRIFICADO Y COBRE



CON LLAVE TAMBIÉN DISPONIBLE

100 M/M	E	*
110 M/M	E	*
120 M/M	E	*
125 M/M	E	*
150 M/M	E	*
175 M/M	E	*
200 M/M	E	*
250 M/M	E	*
300 M/M	E	*
350 M/M		*
400 M/M		*
450 M/M		*
500 M/M		*
550 M/M		*
600 M/M		*

CERRAJERIA

**Bellido**<sup>®</sup>

## TUBOS, CODOS Y ACCESORIOS INOXIDABLE MODULAR (DOBLE PARED)

<b>SERIE DOBLE PARED TUBOS INOX.</b>  	DIÁMETRO mm.	LARGO 0,25 cm.	LARGO 0,50 cm.	LARGO 100 cm.
	125 M/M	*	*	E
	150 M/M	*	*	E
	175 M/M	*	*	E
	200 M/M	*	*	E
	250 M/M	*	*	E
	300 M/M	*	*	E

<b>SERIE DOBLE PARED TUBO REGULABLE</b>  	DIÁMETRO mm.	25-45 CM.	45-95 CM.
	125 M/M	*	*
	150 M/M	*	*
	175 M/M	*	*
	200 M/M	*	*
	250 M/M	*	*
	300 M/M	*	*

<b>SERIE DOBLE PARED TES, CODOS 45° - 90°</b>  	DIÁMETRO mm.	90°	45°	TE de 90° con tapa
	125 M/M	*	*	*
	150 M/M	E	E	*
	175 M/M	*	*	*
	200 M/M	E	E	*
	250 M/M	*	*	*
	300 M/M	*	*	*

<b>SERIE DOBLE PARED DEFLECTOR FINAL - DEFLECTOR CÓNICO ADAPTADOR CALDERA</b>  	DIÁMETRO mm.	DEFLECTOR	CÓNICO	ADAPTADOR CALDERA
	125 M/M	*	*	*
	150 M/M	*	*	*
	175 M/M	*	*	*
	200 M/M	*	*	*
	250 M/M	*	*	*
	300 M/M	*	*	*

<b>SERIE DOBLE PARED SOPORTE PARED - ABRAZADERA UNIÓN</b>  	DIÁMETRO mm.	SOPORTE PARED	ABRAZADERA DE UNIÓN
	125 M/M	*	*
	150 M/M	*	E
	175 M/M	*	*
	200 M/M	*	E
	250 M/M	*	*
	300 M/M	*	*

**DIÁMETROS SUPERIORES: SE FABRICAN SOBRE ENCARGO**

Nº de Homologación CHM-0080-P  
EN ACERO INOXIDABLE AISI 304 (18/10) Cr. Ni.

Producto conforme a instrucción técnica IT-IC.08 para chimeneas y conductos de humos: Conforme a las normas de la Directiva Europea de Productos de la Construcción (Nº89/106 del 21-12-88).

- Aislamiento en MANTA DE FIBRA CERÁMICA de espesor 25 mm. y densidad de 128 kg/m<sup>3</sup>.  
Producto clasificado NO COMBUSTIBLE según la Norma IMCO, resolución A-270 (VIII).

-Soporta temperaturas hasta 450°C.

-Estanquidad total





## TUBO HELICOIDAL Y MANGUITOS DE UNIÓN

### SERIE GALVANIZADA TUBERÍA DE 3,00 MTS.



Manguito  
Simple

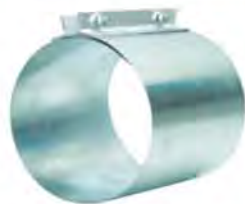

Manguito  
Cincho

PARA LARGOS ESPECIALES, CONSULTAR A FÁBRICA.

DIÁMETRO mm.	GALVA	MANGUITO SIMPLE	MANGUITO CINCHO
100 M/M	E	E	E
125 M/M	E	E	E
150 M/M	E	E	E
175 M/M	E	E	E
200 M/M	E	E	E
250 M/M	E	E	E
300 M/M	E	E	E
350 M/M	*	*	*
400 M/M	*	*	*
450 M/M	*	*	*
500 M/M	*	*	*
550 M/M	*	*	*
600 M/M	*	*	*

## CODOS CHIMENEA 45° Y 90°

### SERIE GALVANIZADA



45°



90°



45°



90°

ESPECIAL ASPIRACIÓN Y VENTILACIÓN

DIÁMETRO mm.	GALVA 45°		GALVA 90°	
	2 SECTOR		3 SECTOR	
100 M/M	E	E	E	E
110 M/M	E	E	E	E
120 M/M	E	E	E	E
125 M/M	E	E	E	E
150 M/M	E	E	E	E
175 M/M	E	E	E	E
200 M/M	E	E	E	E
250 M/M	E	E	E	E
300 M/M	E	E	E	E
	3 SECTOR		5 SECTOR	
350 M/M	*	*	*	*
400 M/M	*	*	*	*
450 M/M	*	*	*	*
500 M/M	*	*	*	*
550 M/M	*	*	*	*
600 M/M	*	*	*	*

### SERIE INOXIDABLE



45°



90°

ESPECIAL ASPIRACIÓN Y VENTILACIÓN

DIÁMETRO mm.	GALVA 45°		GALVA 90°	
	2 SECTOR		3 SECTOR	
100 M/M	E	E	E	E
110 M/M	E	E	E	E
120 M/M	E	E	E	E
125 M/M	E	E	E	E
150 M/M	E	E	E	E
175 M/M	E	E	E	E
200 M/M	E	E	E	E
250 M/M	E	E	E	E
300 M/M	E	E	E	E
	3 SECTOR		5 SECTOR	
350 M/M	*	*	*	*
400 M/M	*	*	*	*
450 M/M	*	*	*	*
500 M/M	*	*	*	*
550 M/M	*	*	*	*
600 M/M	*	*	*	*

CERRAJERIA

**Bellido**®

## CODOS CHIMENEA 45° Y 90°

<b>SERIE VITRIFICADA</b> VITRIFICADO EN NEGRO RESISTENTE HASTA 850° C		DIÁMETRO mm.	45°	90°
		 45°	 90°	100 M/M
		110 M/M	E	E
		120 M/M	E	E
		125 M/M	E	E
		150 M/M	E	E
		175 M/M	E	E
		200 M/M	E	E
		250 M/M	E	E
		300 M/M	E	E

<b>SERIE ANTICALORICA</b> GRIS ANTRACITA PINTURA ALTA TEMPERATURA HASTA 600 °C		DIÁMETRO mm.	45°	90°
		 45°	 90°	
		100 M/M	E	E
		110 M/M	E	E
		120 M/M	E	E
		125 M/M	E	E
		150 M/M	E	E
		175 MM	E	E
		200 M/M	E	E
		250 M/M	E	E
		300 M/M	E	E

<b>SERIE COBRE</b> ESTA SERIE ESTA PENSADA, PARA INSTALACIONES DE VENTILACION.		DIÁMETRO mm.	45°	90°
		 45°	 90°	
		100 M/M	*	*
		110 M/M	*	*
		120 M/M	*	*
		125 M/M	*	*
		150 M/M	*	*
		175 M/M	*	*
		200 M/M	*	*
		250 M/M	*	*
		300 M/M	*	*
			<b>3 SECTOR</b>	<b>5 SECTOR</b>
 45°	 90°	350 M/M	*	*
		400 M/M	*	*
		450 M/M	*	*
		500 M/M	*	*
		550 M/M	*	*
		600 M/M	*	*

## TES DE 45° Y 90°

SE PUEDE FABRICAR CUALQUIER TIPO DE DERIVACION.  
PARA MEDIDAS SUPERIORES PREGUNTAR A FABRICA POR ENCARGO SE PUEDE FABRICAR EN VITRIFICADO



45°

90°

DIÁMETRO mm.	GALVANIZADO	ACERO INOXIDABLE	COBRE	OTROS COLORES
100 M/M	*	*	*	*
110 M/M	*	*	*	*
120 M/M	*	*	*	*
125 M/M	*	*	*	*
150 M/M	*	*	*	*
175 M/M	*	*	*	*
200 M/M	*	*	*	*
250 M/M	*	*	*	*
300 M/M	*	*	*	*
350 M/M	*	*	*	*
400 M/M	*	*	*	*
450 M/M	*	*	*	*
500 M/M	*	*	*	*
550 M/M	*	*	*	*
600 M/M	*	*	*	*

## TAPONES PARA TE

POR ENCARGO SE PUEDE FABRICAR EN VITRIFICADO



DIÁMETRO mm.	GALVANIZADO	ACERO INOXIDABLE	COBRE	OTROS COLORES
100 M/M	*	*	*	*
110 M/M	*	*	*	*
120 M/M	*	*	*	*
125 M/M	*	*	*	*
150 M/M	*	*	*	*
175 M/M	*	*	*	*
200 M/M	*	*	*	*
250 M/M	*	*	*	*
300 M/M	*	*	*	*
350 M/M	*	*	*	*
400 M/M	*	*	*	*
450 M/M	*	*	*	*
500 M/M	*	*	*	*
550 M/M	*	*	*	*
600 M/M	*	*	*	*

## PLAFONES Y TAPAJUNTAS



DIÁMETRO mm.	GALVANIZADO	ACERO INOXIDABLE	COBRE	OTROS COLORES	VITRIFICADO 850°
100 M/M	*	*	*	*	E
110 M/M	*	*	*	*	E
120 M/M	*	*	*	*	E
125 M/M	*	*	*	*	E
150 M/M	*	*	*	*	E
175 M/M	*	*	*	*	E
200 M/M	*	*	*	*	E
250 M/M	*	*	*	*	E
300 M/M	*	*	*	*	NO

CERRAJERIA

**Bellido**<sup>®</sup>

## SOMBRERETES

		DIÁMETRO mm.	GIRATORIO	FIJO	ANTORREVOCANTE	ASPIRADOR
<b>SERIE GALVANZADA</b>		100 M/M	E	E	E	E
		110 M/M	E	E	E	E
		120 M/M	E	E	E	E
		125 M/M	E	E	E	E
		150 M/M	E	E	E	E
		175 M/M	E	E	E	E
		200 M/M	E	E	E	E
		250 M/M	E	E	E	E
		300 M/M	E	E	E	E
		350 M/M	E	*		E
		400 M/M	E	*		
		450 M/M		*		
		500 M/M		*		
		550 M/M		*		
		600 M/M		*		



Sombretes giratorios



Sombretes fijos o chinos

DIÁMETRO mm.	GIRATORIO	FIJO	ANTORREVOCANTE	ASPIRADOR
--------------	-----------	------	----------------	-----------

<b>SERIE VITRIFICADO</b>		100 M/M	E	E	E	
		110 M/M	E	E	E	
		120 M/M	E	E	E	
		125 M/M	E	E	E	
		150 M/M	E	E	E	
		175 M/M	E	E	E	
		200 M/M	E	E	E	
		250 M/M	E	E	E	
		300 M/M	E	E	E	



DIÁMETRO mm.	GIRATORIO	FIJO	ANTORREVOCANTE	ASPIRADOR
--------------	-----------	------	----------------	-----------

<b>SERIE INOXIDABLE</b>		100 M/M	*	*	*	*
		110 M/M	*	*	*	*
		120 M/M	*	*	*	*
		125 M/M	*	*	*	*
		150 M/M	*	*	*	*
		175 M/M	*	*	*	*
		200 M/M	*	*	*	*
		250 M/M	*	*	*	*
		300 M/M	*	*	*	*
		350 M/M	*	*	*	*
		400 M/M	*	*		
		450 M/M		*		
		500 M/M		*		
		550 M/M		*		
		600 M/M		*		



Sombretes antirrevocantes



Sombretes aspiradores o extractores

## SOMBRERETES

	DIÁMETRO mm.	GIRATORIO	FIJO	ANTORREVOCANTE	ASPIRADOR
<b>SERIE COBRE</b> 	100 M/M	*	*	*	
	110 M/M	*	*	*	
	120 M/M	*	*	*	
	125 M/M	*	*	*	
	150 M/M	*	*	*	
	175 M/M	*	*	*	
	200 M/M	*	*	*	
	250 M/M	*	*	*	
	300 M/M	*	*	*	
	350 M/M	*	*		
	400 M/M	*	*		
	450 M/M		*		
	500 M/M		*		
	550 M/M		*		
	600 M/M		*		

DIÁMETRO mm.	GIRATORIO	FIJO	ANTORREVOCANTE	ASPIRADOR
--------------	-----------	------	----------------	-----------

	DIÁMETRO mm.	GIRATORIO	FIJO	ANTORREVOCANTE	ASPIRADOR
<b>SERIE COLORES</b> 	100 M/M	*	*	*	E
	110 M/M	*	*	*	E
	120 M/M	*	*	*	E
	125 M/M	*	*	*	E
	150 M/M	*	*	*	E
	175 M/M	*	*	*	E
	200 M/M	*	*	*	E
	250 M/M	*	*	*	E
	300 M/M	*	*	*	E
	350 M/M	*	*	*	E
	400 M/M	*	*		
	450 M/M		*		
	500 M/M		*		
	550 M/M		*		
	600 M/M		*		

## BASES O ARRANQUE PARA SOMBRERETES

- ADAPTADOR PARA SOMBRERETE ASPIRADOR EN CUBIERTAS DE NAVES INDUSTRIALES.
- SE PUEDE FABRICAR PARA CABALLETE DE UN AGUA Y DOS AGUAS.

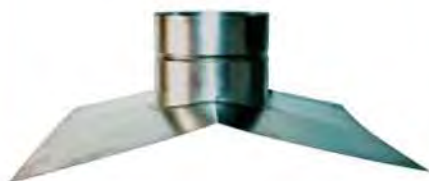

DIÁMETRO mm.	GIRATORIO	FIJO	ANTORREVOCANTE	ASPIRADOR
--------------	-----------	------	----------------	-----------

100 M/M	E	*	E	
110 M/M	E	*	E	
120 M/M	E	*	E	
125 M/M	E	*	E	
150 M/M	E	*	E	
175 M/M	E	*	E	
200 M/M	E	*	E	
250 M/M	E	*	E	
300 M/M	E	*	E	
350 M/M	E	*	E	

CERRAJERIA

**Bellido**®

## RESPIRADEROS PARA NAVES INDUSTRIALES

- RESPIRADERO FIJO PARA VENTILACION DE NAVES INDUSTRIALES
- ADAPTABLE SOBRE CABALLETE EN CUBIERTAS DE DOS AGUAS.

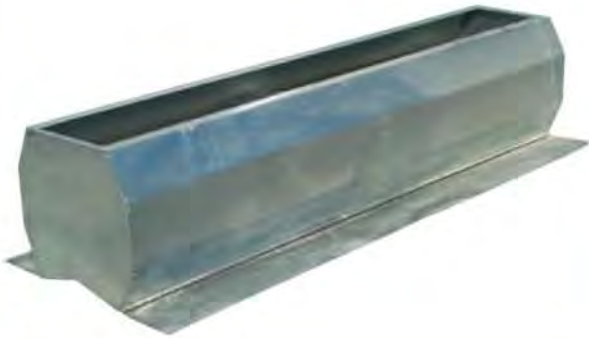

DIÁMETRO mm.	LARGO EN MTS	GALVANIZADO	OTROS COLORES
450X450	1,00 MTS	E	E
450X450	2,00 MTS	E	E

## SOMBRETE FIJO ESTÁTICO

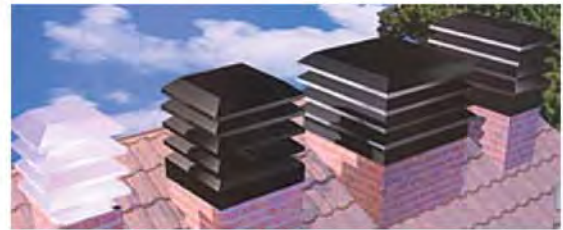

### MEDIDAS EN STOK PARA COLOCACION SOBRE OBRA

MEDIDA INTERIOR	200X200	250X250	300X300	400X400	500X500	600X600
MEDIDA EXTERIOR	340X340	390X390	440X440	540X540	640X640	740X740

## CONDUCTOS CUADRADOS PARA VENTILACIÓN

BAJO PEDIDO, ESTAMOS CAPACITADOS PARA FABRICAR Y SUMINISTRAR TODO TIPO DE CONDUCTOS Y ACCESORIOS DE VENTILACION.



CERRAJERIA

**Bellido**®

## REDUCCIONES Y AMPLIACIONES

• POR ENCARGO, SE PUEDEN FABRICAR  
AMPLIACIONES EN VITRIFICADO



DIÁMETRO mm.	GALVANIZADO	VITRIFICADO 850*	INOXIDABLE	COBRE	OTROS COLORES
110-100	E	E	E	*	*
120-100	E	E	E	*	*
120-110	E	E	E	*	*
125-120	E	E	E	*	*
150-120	E	E	E	*	*
175-150	E	E	E	*	*
200-150	E	E	E	*	*
200-175	E	E	E	*	*
250-200	E	E	E	*	*
300-250	E	E	E	*	*
350-300	E	NO	E	*	*
400-350	E	NO	E	*	*
450-400	E	NO	E	*	*
500-450	E	NO	E	*	*
550-500	E	NO	E	*	*
600-550	E	NO	E	*	*

## ABRAZADERAS METÁLICAS

• DISPONIBLE CON TORNILLO



Pistola

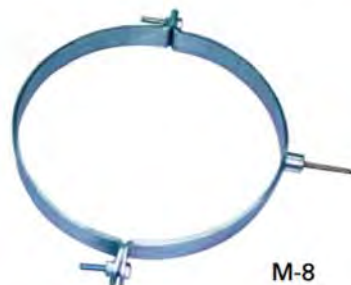

M-8

DIÁMETRO mm.	GALVANIZADO	INOXIDABLE	COBRE	OTROS COLORES	EMBALADAS EN UNIDS.
75	E	*	*	E	100
90	E	*	*	E	100
100	E	*	*	*	100
110	E	*	*	*	100
120	E	*	*	*	100
125	E	*	*	*	100
150	E	*	*	*	100
175	E	*	*	*	100
200	E	*	*	*	50
250	E	*	*	*	25
300	E	*	*	*	25
350	E	*	*	*	25
400	E	*	*	*	25
450	E	*	*	*	25
500	E	*	*	*	25
550	E	*	*	*	25
600	E	*	*	*	25

CERRAJERIA

**Bellido**<sup>®</sup>

## PUERTAS METÁLICAS



MODELO	DERECHAS		IZQUIERDAS		MEDIDA m/m.	MEDIDA m/m.
	SIN VENTILACION	VENTILACION	SIN VENTILACION	VENTILACION	HUECO OBRA	PASO HOJA
<b>GALVANIZADAS</b>						
70	E	E	E	E	700X2015	620X1970
80	E	E	E	E	800X2015	720X1970
90	E	E	E	E	900X2015	820X1970
100	NO	E	NO	E	1000X2015	920X1970
<b>LACADAS BLANCO</b>						
70	E	E	E	E	700X2015	620X1970
80	E	E	E	E	800X2015	720X1970
90	E	E	E	E	900X2015	820X1970
100	NO	E	NO	E	1000X2015	820X1970

NOTA: DISPONEMOS DE PUERTAS CORTA-FUEGOS ( RF-60 )

## CASETILLAS PARA CALENTADORES

GALVANIZADO	LACADO BLANCO	INOXIDABLE	COBRE	OTROS COLORES
-------------	---------------	------------	-------	---------------

CASETA PARA CALENTADOR DE 10 A 11 LITROS



E	E	*	*	*
---	---	---	---	---

## OTRAS POSIBLES FORMAS QUE SE FABRICAN



CANAL MAESTRA

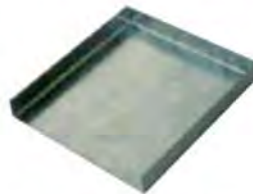

TAPA CANAL MAESTRA



REMATE

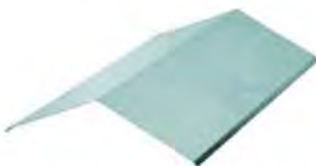

CABALLETE/CUMBRERA

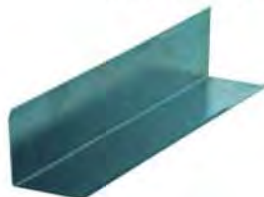

ANGULO



LIMAHOYA CUADRADO/REDONDO

CERRAJERIA

**Bellido**<sup>®</sup>





**Avda. Málaga, 16 - 14550 MONTILLA (Córdoba)**

**T. 957651340 - F. 957653870 - M. 616239201**

**[www.cerrajeriabellido.com](http://www.cerrajeriabellido.com) - [bellido@cerrajeriabellido.com](mailto:bellido@cerrajeriabellido.com)**





VENTILACIÓN Y ACCESORIOS  
PARA CUBIERTAS

**BELLIDO**<sup>®</sup>  
MANUFACTURAS METÁLICAS

**ÍNDICE**

**ACABADOS ..... PAG. 3**

**VENTILACION EN CUBIERTAS**

**ASPIRADOR/EXTRACTOR EÓLICO INDUSTRIAL ..... PAG. 4**

**ACCESOS A CUBIERTAS ..... PAG. 4**

**TERMINALES DE CHIMENEAS ..... PAG. 5**

**ARRANQUES O COGIDAS A CUBIERTA ..... PAG. 5**

**RECOGIDA AGUAS PLUVIALES**

**TUBOS Y ACCESORIOS ..... PAG. 6**  
**(ABRAZADERAS, CODOS, BOQUILLAS, PARAHOJAS, ETC.)**

**BOQUILLAS DE ACOPLA ..... PAG. 7**

**GÁRGOLAS O ALIVIADEROS DE CANAL MAESTRA ..... PAG. 7**

## AL NATURAL

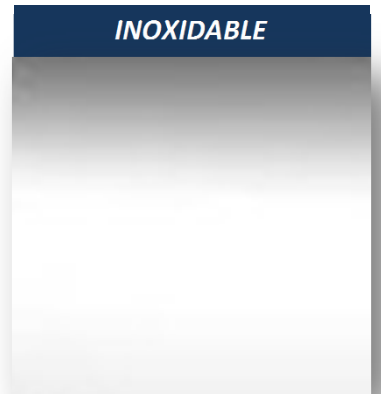

\* SÓLO EN ASPIRADOR EÓLICO INDUSTRIAL

## LACADOS

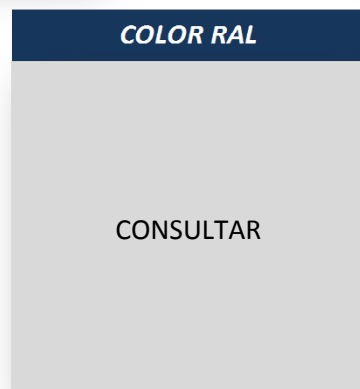
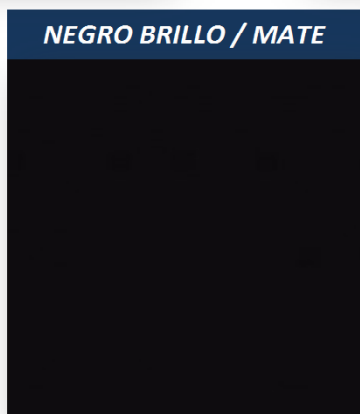
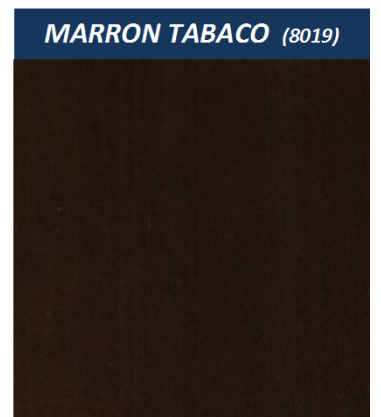
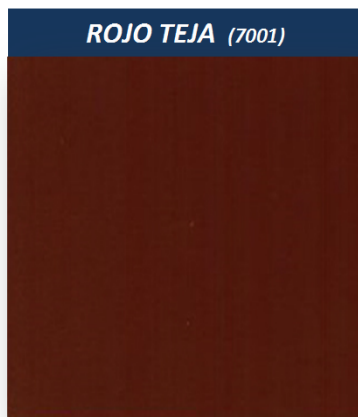
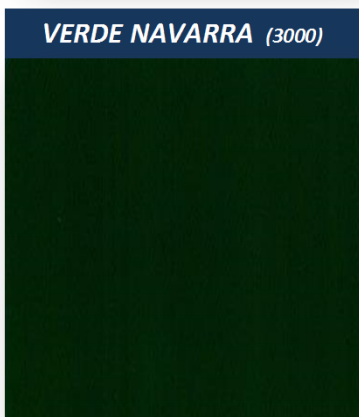
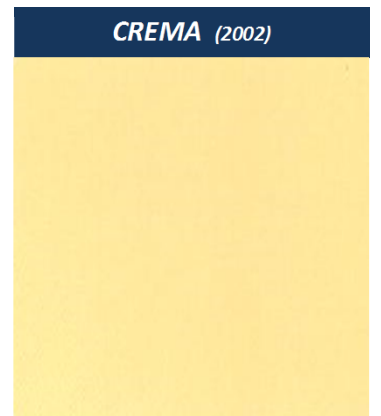
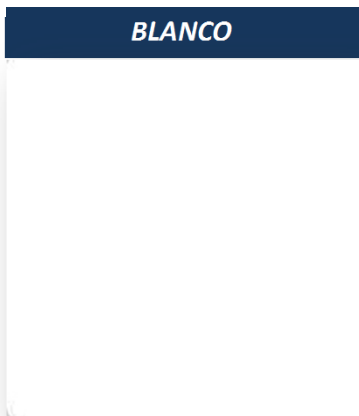

NOTA IMPORTANTE:  
Los colores muestra aquí reflejados son orientativos, no tienen validez contractual.

# ASPIRADOR/EXTRACTOR EÓLICO INDUSTRIAL

para ventilación de naves industriales  
gran capacidad de renovación

## ALUMINIO

Ø 400 - 500



diámetro (mm)

viento (km/h)	extracción m3/h	Ø 400	Ø 500
	10	1750	2640
15	2450	3650	
20	3100	4700	

Habitualmente denominado como sombrerete Aspirador. De facil adaptación a cualquier cubierta mediante arranque.

Fabricación: base en acero galvanizado y bombo en aluminio.

Su funcionamiento se basa en el aprovechamiento de la energía eólica, a autoregulación de su sistema de rotación y en la diferencia de temperatura (°C) existente entre el interior y el exterior de la nave.

Podemos decir que aunque es aireador estático la energía eólica lo convierte en dinámico, mejorando las prestaciones de extracción respecto a otros modelos y sabiendo que no produce ningún tipo de energía eléctrica.

\* MONTADO SOBRE 2 RODAMIENTOS EN ACERO INOXIDABLE TIPO S 6002-2RS SNR.

\* BAJO PEDIDO SE PUEDE SUMINISTRAR LACADO CON EL MISMO RAL DE LA CUBIERTA.

**ARRANQUE O BASE DE COGIDA A CUBIERTA** (1 ó 2 aguas) NO INCLUIDA  
Dimensión: **1,00 x 1,00 m.** para diámetro (mm) 400 - 500 (ver pag. 5)

## GALVANIZADO

Ø 200 - 250 - 300



## LACADO

Ø 200 - 250 - 300



## INOXIDABLE

Ø 200 - 250 - 300



diámetro (mm)

viento (km/h)	extracción m3/h	Ø 200	Ø 250	Ø 300
	10	375	680	862
15	435	750	997	
20	525	862	1125	

\*otras dimensiones consultar

De aspecto similar al ASPIRADOR EÓLICO INDUSTRIAL DE ALUMINIO, a precio muy económico y de facil adaptación a cualquier cubierta mediante arranque.

Fabricación: acero galvanizado o acero inoxidable (disponible terminación lacado).

**ARRANQUE O BASE DE COGIDA A CUBIERTA** (1 ó 2 aguas) NO INCLUIDA  
Dimensión: **0,62 x 0,62 m.** para diámetro (mm) 200 - 250 - 300 (ver pag. 5)

## ACCESOS A CUBIERTAS

### 1 PUERTA BASCULANTE

GALVANIZ. - LACADO - INOX.

a medida



# TERMINALES DE CHIMENEAS

## Fabricación:

- Estructura en chapa galvanizada de 1,5mm. de espesor, lamas, techo y base en espesor 1mm.
- Electrosoldada por puntos.
- Lamas dispuestas a modo de persiana mallorquina.
- Acabado esmaltado al horno con pintura epoxi a 400 °C

## Dimensiones:

- A MEDIDA, ANCHO Y FONDO según necesidades de cliente.
- Altura: 4 lamas 40 cm. y 5 lamas 45 cm.
- Profundidad de la encastración en chimenea de 10 cm.

## 4 LAMAS

GALVANIZ. - LACADO - INOX.

*a medida*



## 5 LAMAS

GALVANIZ. - LACADO - INOX.

*a medida*

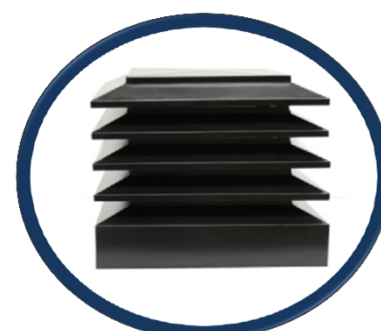

## CHINO

GALVANIZ. - LACADO - INOX

Ø 100 - 110 - 120 - 125 - 150

175 - 200 - 250 - 300



## ANTIRREVOCANTE

GALVANIZ. - LACADO - INOX

Ø 100 - 110 - 120 - 125 - 150

175 - 200 - 250 - 300



## GIRATORIO

GALVANIZ. - LACADO - INOX

Ø 100 - 110 - 120 - 125 - 150

175 - 200 - 250 - 300



*otras dimensiones consultar*

# ARRANQUES O COGIDAS A CUBIERTA

## 2 AGUAS

GALVANIZ. - LACADO - INOX.

Ø 200 - 250 - 300 - 400 - 500

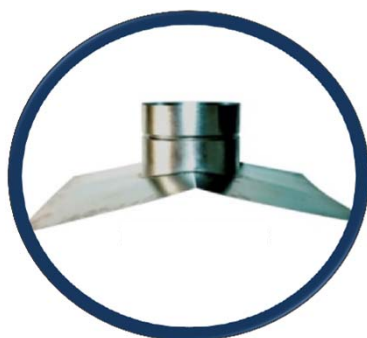

## 1 AGUA

GALVANIZ. - LACADO - INOX.

Ø 200 - 250 - 300 - 400 - 500

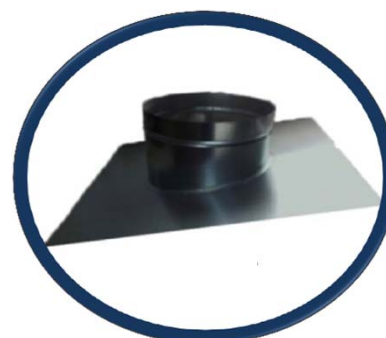

# TUBOS Y ACCESORIOS

## **TUBO** (long. 1m)

**GALVANIZ. - LACADO - INOX.**

Ø 75 - 90 - 100 - 110 - 125  
150 - 160 - 200

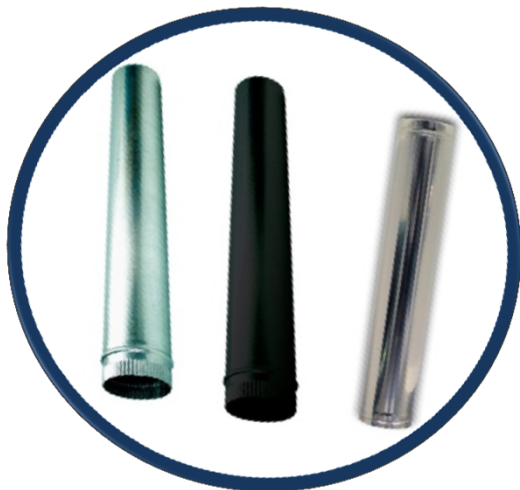

## **ABRAZADERA**

**GALVANIZ. - LACADA - INOX** (cogida M-8)

Ø 75 - 90 - 100 - 110 - 125  
150 - 160 - 200



## **CODOS** (45º - 90º)

**GALVANIZ. - LACADO - INOX.**

Ø 75 - 90 - 100 - 110 - 125  
150 - 160 - 200



## **CODOS TELESCÓPICOS**

**GALVANIZ. - LACADO - INOX.**

Ø 75 - 90 - 100 - 110 - 125  
150 - 160 - 200

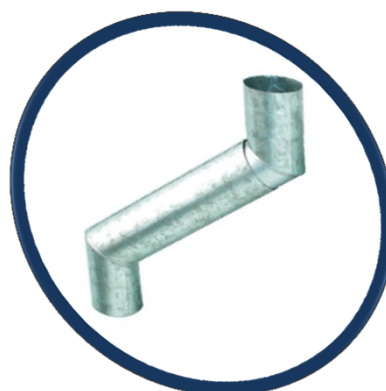

## **BOQUILLA DE CANAL**

**GALVANIZ. - LACADA - INOX** (ala 18mm)

Ø 75 - 90 - 100 - 110 - 125  
150 - 160 - 200



## **PARAHOJAS ó PARAGRAVILLAS**

**INOXIDABLE**

Ø 75x125 - 150x250 - 260x360



# BOQUILLAS DE ACOPLA

**Fabricación:**

- Estructura en chapa de espesor, material y terminación a solicitud del cliente.
- Electrosoldada por puntos sellado.
- Sellado con adhesivo de polímero.

**Dimensiones:**

- A MEDIDA, INDICAR CON DETALLE TODAS LAS DIMENSIONES

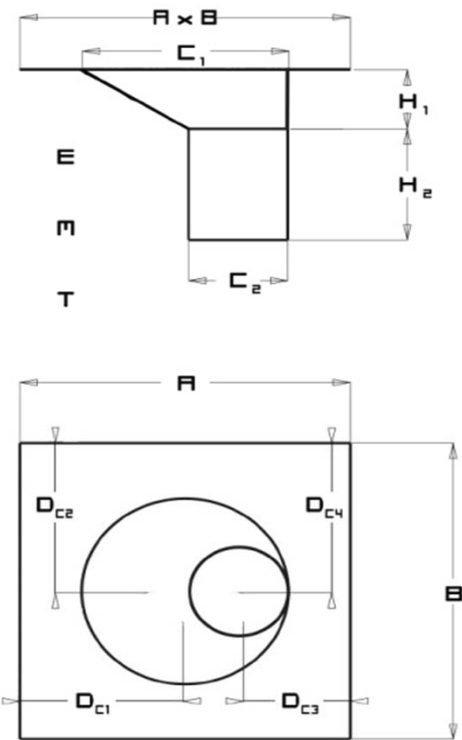

**BOQUILLA ESPECIAL**  
**GALVANIZ. - LACADO - INOX.**  
*a medida*



# GÁRGOLAS O ALVIADEROS DE CANAL MAESTRA

**Fabricación:**

- Estructura en chapa de espesor, material y terminación a solicitud del cliente.
- Electrosoldada por puntos sellado.
- Sellado con adhesivo de polímero.
- Con o sin rebosadero.
- Con o sin tapa de registro.

**Dimensiones:**

- A MEDIDA, INDICAR CON DETALLE TODAS LAS DIMENSIONES

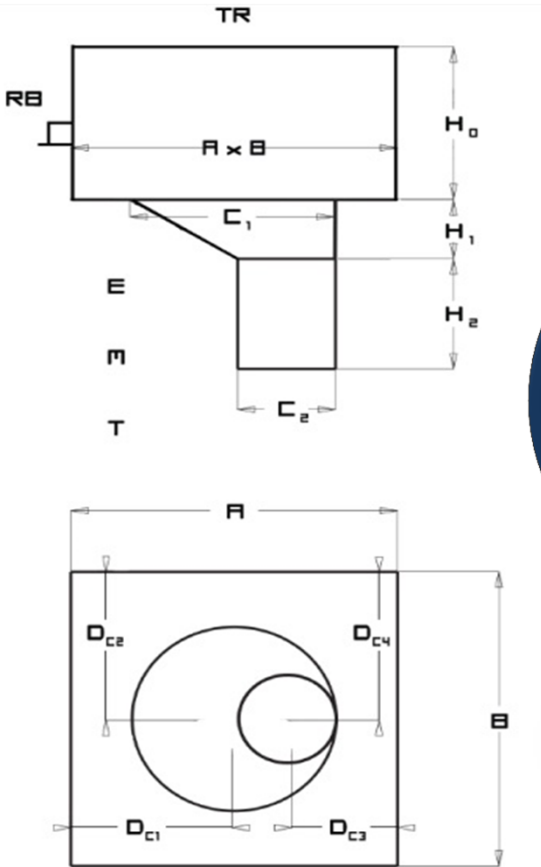

**GÁRGOLA**  
**GALVANIZ. - LACADO - INOX.**  
*a medida*







**BELLIDO MANUFACTURAS METALICAS, S.L.**

AVDA. MÁLAGA, 16 - 14550 MONTILLA (CÓRDOBA) ESPAÑA

T. +34 957651340

M. +34 616239201

F. +34 957653780

[WWW.CERRAJERIABELLIDO.COM](http://WWW.CERRAJERIABELLIDO.COM)

[BELLIDO@CERRAJERIABELLIDO.COM](mailto:BELLIDO@CERRAJERIABELLIDO.COM)